

■ TECHNICAL SPECIFICATIONS

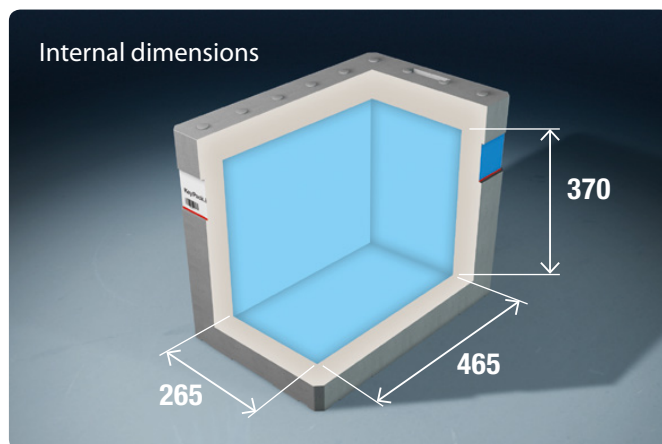

EXTERNAL DIMENSIONS	595 x 395 x h500 mm
INTERNAL DIMENSIONS	465 x 265 x h370 mm
WALLS THICKNESS	65 mm
CONTENT CAPACITY	45 lt
WEIGHT	1,580 kg
MATERIAL DENSITY	22 gr/lt
BASE MATERIAL	graphite enhanced EPS
RECYCLE	100%

■ MODULARITY

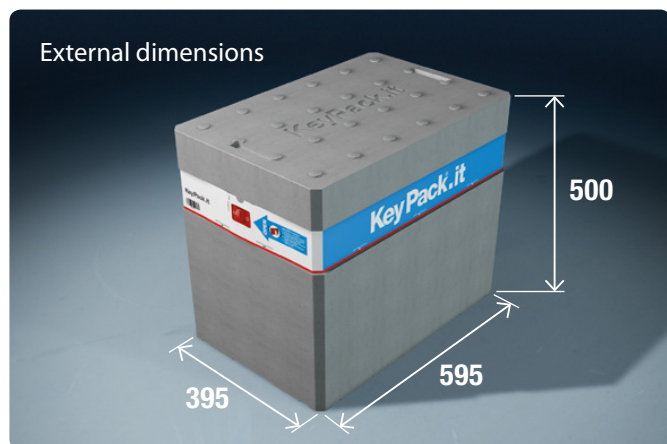
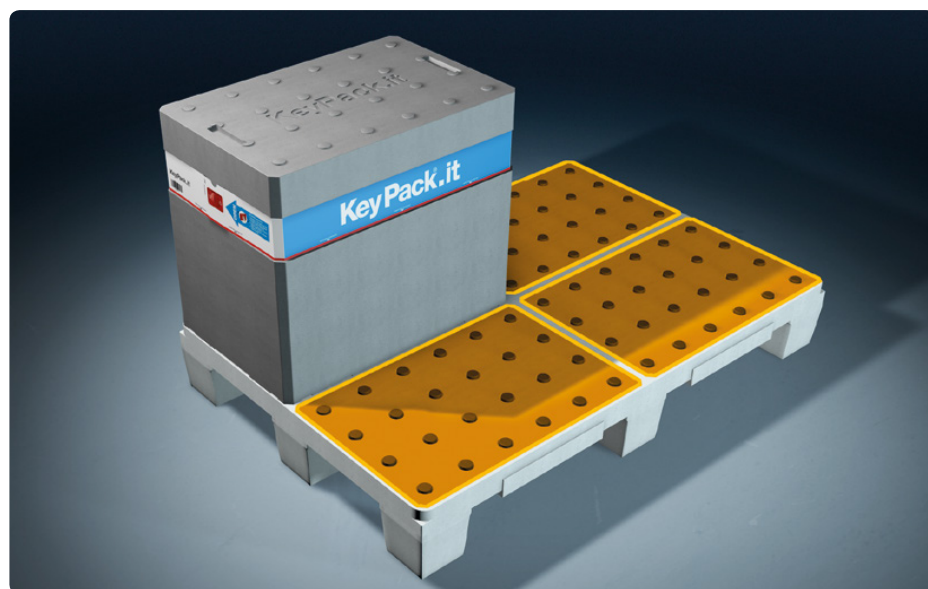

Assembled container positioning on eps pallet.

Container modularity allows neat and precise piling on pallet.

■ PALLET ASSEMBLY

Pallet ready for delivery

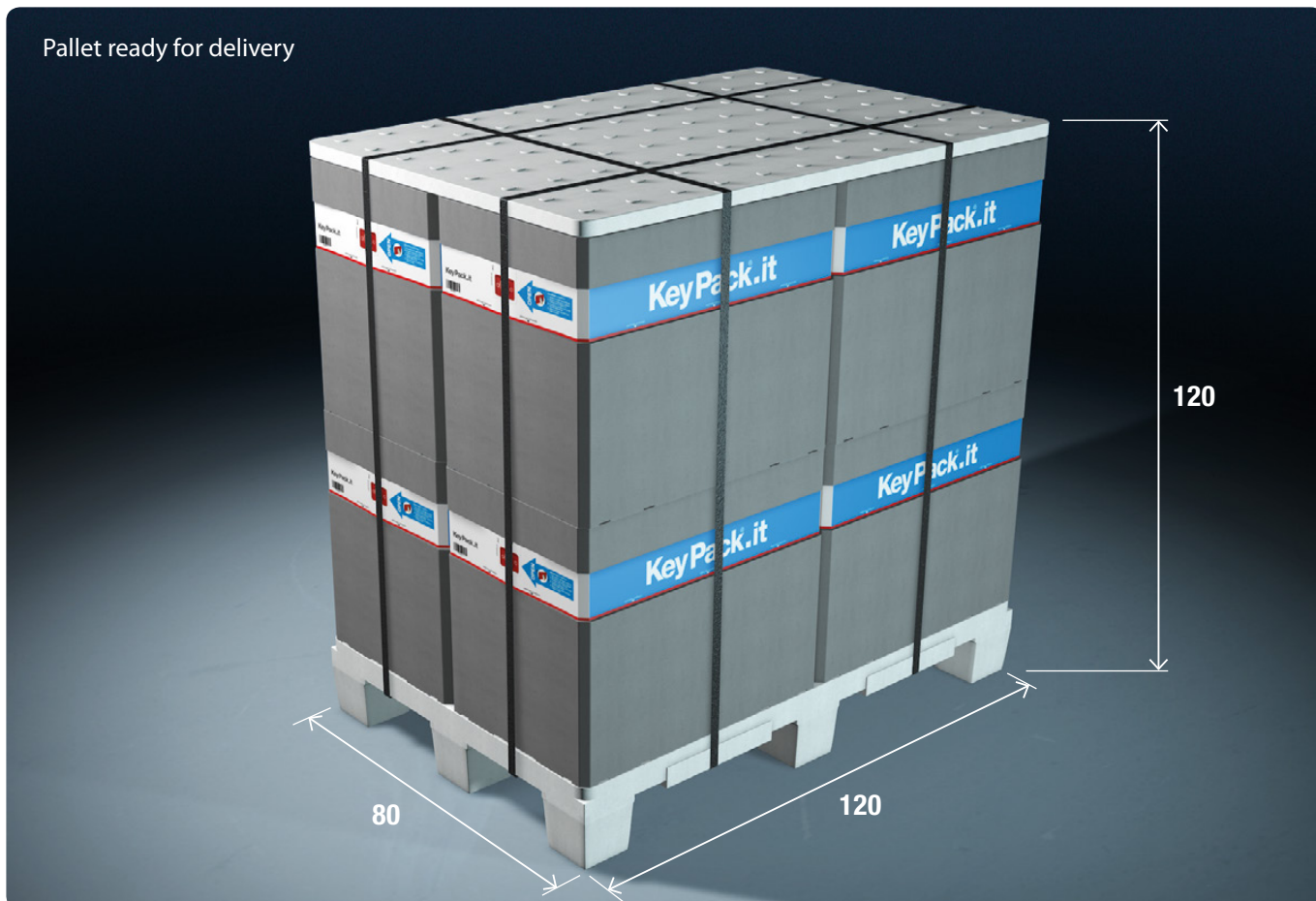

**PALLET DETAILS**

NUMBER OF BOXES	8 including body and lid
WEIGHT	14 kg
DIMENSIONS	120 x 80 x h120 cm

Pallets can be either in **EPS** or, upon request, certified **fumigated wood**.

Discover all exclusive advantages of the whole **KeyPack®system** on our website [www.keypack.it](http://www.keypack.it)