

■ TECHNICAL SPECIFICATIONS

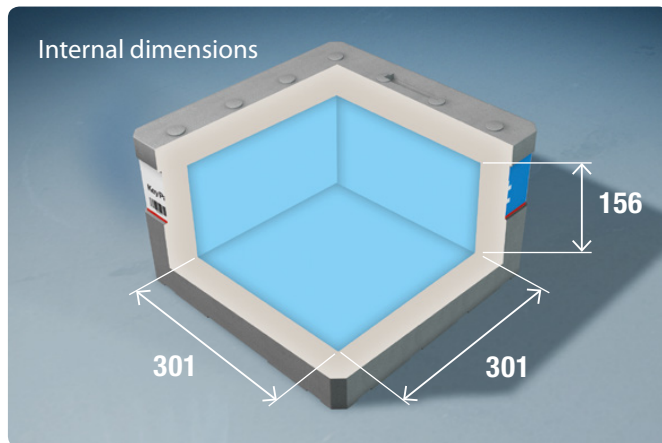

EXTERNAL DIMENSIONS	395 x 395 x h250 mm
INTERNAL DIMENSIONS	301 x 301 x h156 mm
WALLS THICKNESS	47 mm
CONTENT CAPACITY	14 lt
WEIGHT	0,650 kg
MATERIAL DENSITY	22 gr/lt
BASE MATERIAL	graphite enhanced EPS
RECYCLE	100%

■ MODULARITY

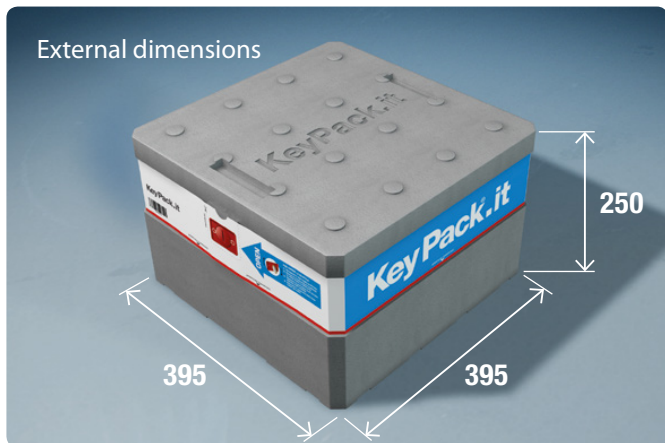
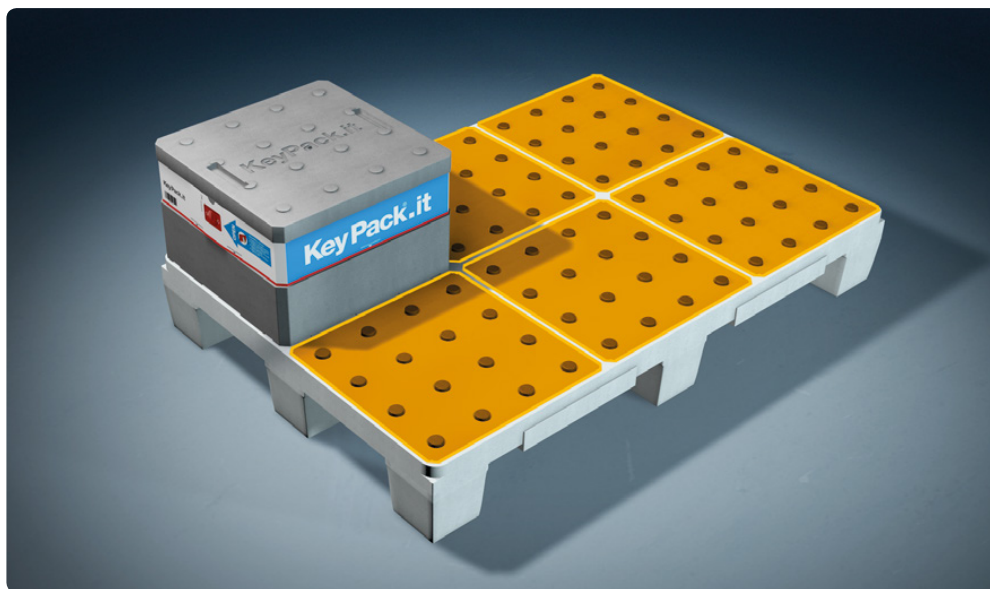

Assembled container positioning on eps pallet.

Container modularity allows neat and precise piling on pallet.

■ PALLET ASSEMBLY

Pallet ready for delivery

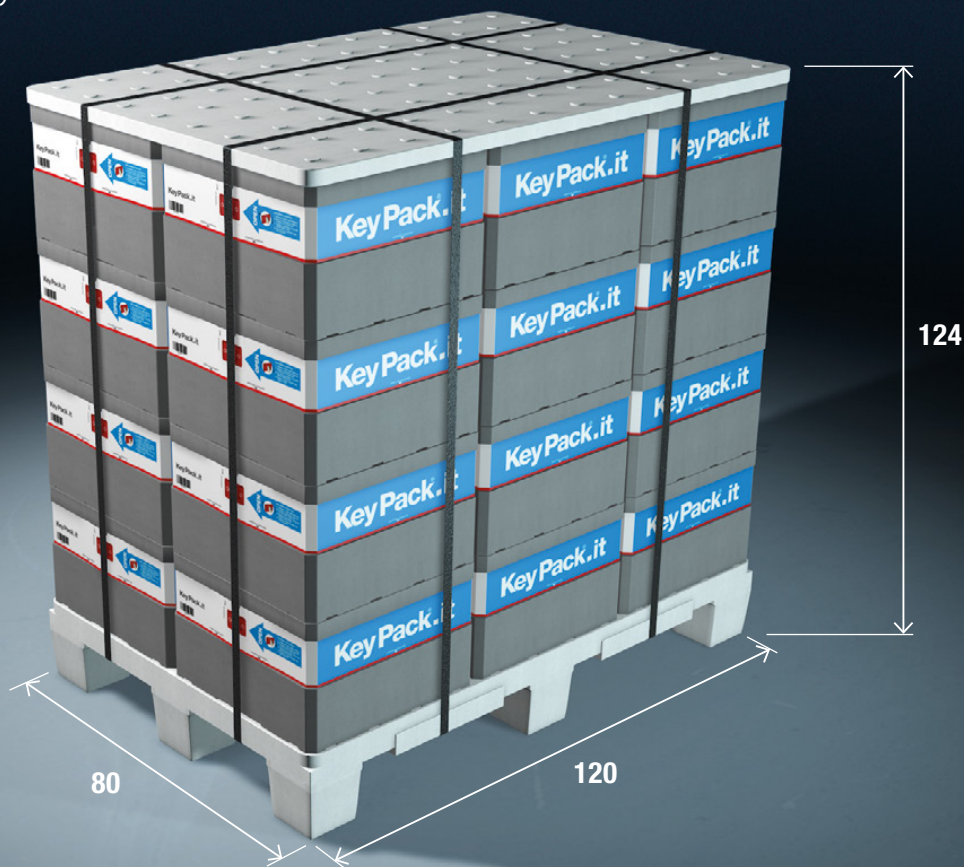

PALLET DETAILS

NUMBER OF BOXES	24 including body and lid
WEIGHT	20 kg
DIMENSIONS	120 x 80 x h124 cm

Pallets can be either in **EPS** or, upon request, certified **fumigated wood**.

Discover all exclusive advantages of the whole **KeyPack®system** on our website www.keypack.it